

330F L/F LN

Hydraulic Excavator

2017



Engine

Engine Model	Cat® C7.1 ACERT™
Power – ISO 14396 (metric)	178 kW (242 PS)
Power – ISO 9249 (metric)	175 kW (238 PS)

Drive

Maximum Travel Speed	5.1 km/h
Maximum Drawbar Pull	247 kN

Weight

Minimum Operating Weight	29 110 kg
Maximum Operating Weight	30 730 kg

The 330F L/F LN is built to keep your production numbers up and your owning and operating costs down.

The machine's C7.1 ACERT engine not only meets EU Stage IV emission standards, but it does so with all the power, fuel efficiency, and reliability you need to be successful.

Where the real power comes in is through Caterpillar's unparalleled systems integration and state-of-the-art hydraulic system. You can literally move tons of material all day long with tremendous speed and precision.

When you add a quiet operator environment that keeps you comfortable and productive, easy-to-reach service points that make routine maintenance simple and fast, and multiple Cat work tools that help you take on a variety of tasks with just one machine, you simply won't find a better, more efficient 30-ton excavator.

If productivity, comfort, versatility, and fuel efficiency are what you want, you need a 330F L/F LN in your fleet.

Contents

Easy to Operate4
Fuel Efficient6
Durable Structures8
Durable Linkages9
Reliable and Productive10
Serviceable12
Safe Work Environment13
Attachments14
Cat Connect Technologies16
Sustainable18
Complete Customer Care18
Specifications19
Standard Equipment34
Optional Equipment35





Easy to Operate

Comfort and convenience to keep you productive all shift long



A Safe, Quiet Cab

The ROPS-certified cab contributes to your comfort thanks to special viscous mounts and special roof lining and sealing, that limit vibration and unnecessary sound. Operators will enjoy the quietness and comfort of the all new cab.

Excellent Ergonomics

Wide seats with air suspension and heat/cooling options, include a reclining back, upper and lower slide adjustments, and height and tilt angle adjustments to meet your needs for maximum comfort.

The fully automatic climate control system keeps operators comfortable and productive all day long in either hot or cold weather.

Storage spaces are located in the front, rear, and side consoles of the cab. A drink holder accommodates a large mug, and a shelf behind the seat stores large lunch or toolboxes.

Power supply sockets are available for charging your electronic devices like an MP3 player, a cell phone, or even a tablet.

Controls Just for You

The right and left joystick consoles can be adjusted to improve your comfort and productivity during the course of a day. The right joystick features a button that will reduce engine speed when you are not working to help save fuel. Touch it once and speed reduces; touch it again and speed increases for normal operation.



Easy to Navigate Monitor

The new LCD monitor is easy to see and navigate. Not only can it memorize up to 10 different work tools, it's also programmable in up to 44 languages to meet today's diverse workforce. The monitor clearly displays critical information you need to operate efficiently and effectively. Plus it projects the image from the standard rearview and side-view camera to help you see what's going on around you so you can stay safely focused on the job at hand.



Fuel Efficient

Powerful and fuel efficient to meet your expectations

Fuel Savers That Add Up

The 330F L/F LN consumes less fuel than the previous series model 329E L, and the automatic engine speed control contributes by lowering rpm when the machine doesn't need it for work.

Automatic engine idle shutdown turns the engine off when it's been idling for more than a specified amount of time that you can set through the monitor. You also have a choice of two power modes – standard or eco modes. Simply change between modes through the console switch panel to meet the work needs in front of you. Collectively, all of these benefits add up to reduced fuel consumption, reduced exhaust and sound emissions, reduced repair and maintenance costs, and increased engine life for you.

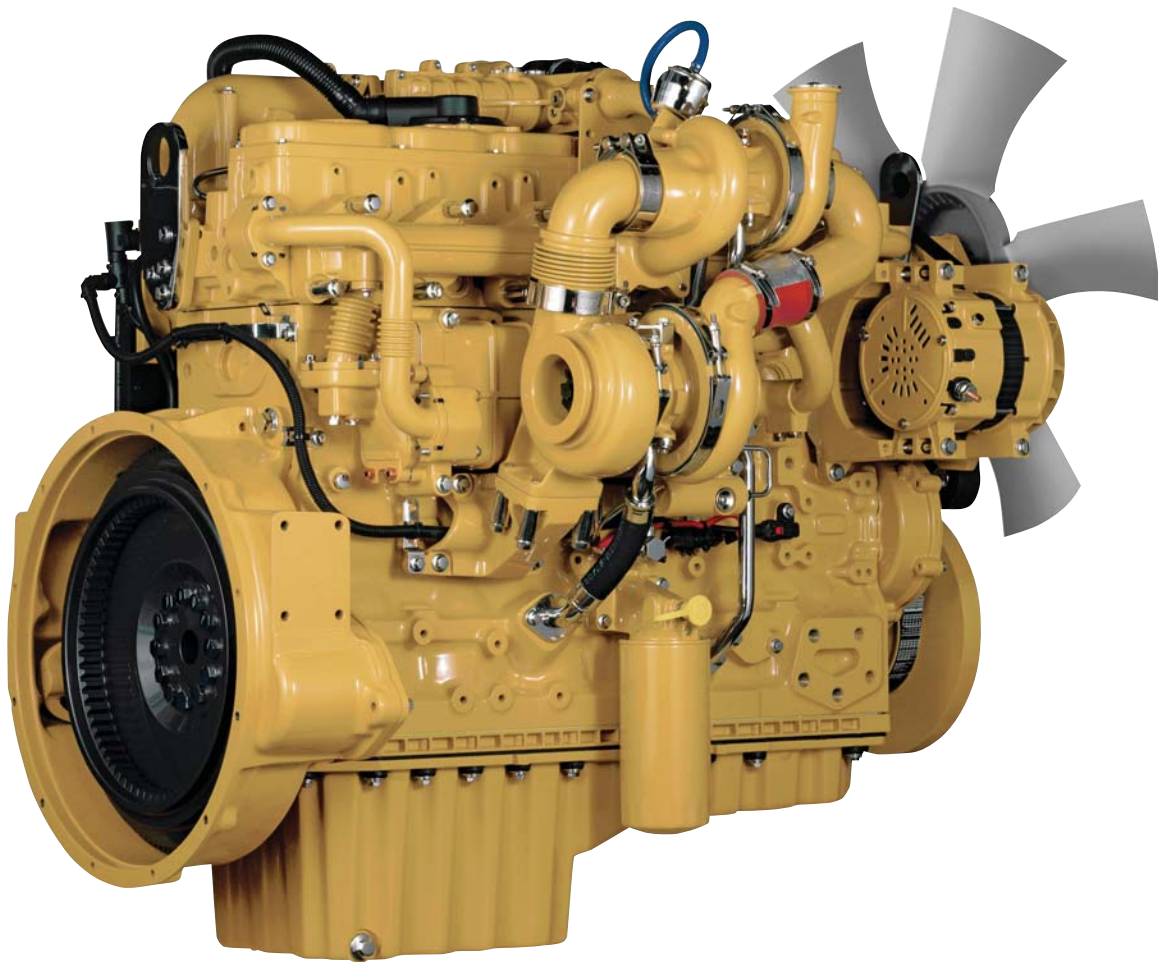

Proven Technology

Every Stage IV ACERT engine is equipped with a combination of proven electronic, fuel, air, and aftertreatment components. Applying these time-tested technologies let us meet your high expectations for productivity, fuel efficiency, reliability, and service life.

Following are the results you can expect:

- **Improved Fluid Efficiency of up to 5%** over Stage IIIB products, including Diesel Exhaust Fluid (DEF) consumption.
- **High Performance** across a variety of applications.
- **Enhanced Reliability** through commonality and simplicity of design.
- **Maximized Uptime and Reduced Cost** with world-class Cat dealer support.
- **Minimized Impact on Emission Systems** – with no operator interaction required.
- **Durability** with long service life.
- **Better Fuel Economy** with minimized maintenance costs.
- **Same Great Power and Response.**

Biodiesel Not a Problem

The C7.1 ACERT engine can run on up to B20 biodiesel fuel that meets ASTM 6751 standards – all to give you more potential fuel-saving flexibility.

A Cool Design for Any Temperature

The 330F L/F LN features a side-by-side cooling system that allows you to put the machine to work in extremely hot and cold conditions. The system is completely separated from the engine compartment to reduce noise and heat. Plus it features easy-to-clean cores and an efficient variable-speed fan.

Diesel Exhaust Fluid (DEF)

Cat engines equipped with an SCR system inject DEF into the exhaust to reduce NO_x emissions. DEF is a precisely mixed solution of 32.5% high purity chemical grade urea and 67.5% de-ionized water. DEF used in Cat SCR systems must meet the requirements outlined in the International Organization for Standardization (ISO) standard 22241-1.



Durable Structures

Designed to work in your tough applications

Robust Frame

The 330F L/F LN is a well-built machine designed to give you a very long service life.

The upper frame has mountings made specifically to support the heavy-duty cab; it is also reinforced around key areas that take on stress like the boom foot and skirt. Massive bolts are used to attach the track frames to the body, and additional bolts are used to increase the machine's digging force, which leads to more productivity for you.

Stable Undercarriages

The 330F Long (L) and 330F Long Narrow (LN) undercarriages contribute significantly to their outstanding stability and durability. Track shoes, links, rollers, idlers, and final drives are all built with long-lasting, high-tensile-strength steel for long-term durability.

Cat Grease Lubricated Track 2 (GLT2) track link protects moving parts by keeping water, debris, and dust out and grease sealed in, which delivers longer wear life and reduced noise when traveling.

Optional guide guards help maintain track alignment to improve the machine's overall performance – whether you're traveling on a flat, heavy bed of rock or a steep, wet field of mud.

Great Weight

The 5.8 mt counterweight is built with thick steel plates and reinforced fabrications to make it less susceptible to damage, designed with curved surfaces that match the machine's sleek, smooth appearance along with integrated housings to help protect the standard rearview and side-view camera.

Durable Linkages

Options to take on your far-reaching
and up-close tasks



Built to Last

The 330F L/F LN is offered with Reach boom and sticks. Each is built with internal baffle plates and stress-relieved for added durability, and each undergoes ultrasound inspection to ensure quality and reliability. Large box-section structures with thick, multi-plate fabrications, castings, and forgings are used in high-stress areas such as the boom nose, boom foot, boom cylinder, and stick foot to improve durability. Also, the boom nose pin retention method is a captured flag design for enhanced durability.

Linkage for Any Job

The Reach boom 6.15 m and sticks (3.2 m, 2.65 m) offer you excellent all-around versatility for general excavation work, including excavating basements, trenching for utility lines, and working in sewer applications.

Sticks are matched to the boom. Longer sticks are better when you need to dig deep or load trucks. Shorter sticks provide greater breakout force.

Pins

All front linkage pins have thick chrome plating, giving them high wear resistance. Each pin diameter is made to distribute the shear and bending loads associated with the stick and to help ensure long pin, boom and stick life.

Talk to your Cat dealer to pick the best front linkage options for your applications.



Reliable and Productive

Power to move your material with speed and precision

Powerful, Efficient Design

When it comes to moving heavy material quickly and efficiently, you need hydraulic horsepower – the type of ground-breaking power the 330F L/F LN can deliver. Major hydraulic components like pumps and valves are located close together so shorter tubes and lines can be used. This design leads to less friction loss, reduced pressure drops, and more power to the ground for the work you need to get done.

The heavy lift mode increases machine system pressure to improve lift – a nice benefit in certain situations. Heavy lift mode also reduces engine speed and pump flow in order to improve controllability.

Control Like No Other

Controllability is one of the main attributes of Cat excavators, and one of the key contributors to this is the main control valve. The valve opens slowly when your range of joystick lever movement is small and opens rapidly when movement is high.

It puts flow where you need it when you need it, which leads to smoother operation, greater efficiency, and lower fuel consumption.

Auxiliary Hydraulics for Added Versatility

Auxiliary hydraulics give you greater tool versatility so you can take on more work with just one machine, and there are several options from which you can choose. A quick coupler circuit, for example, will allow you to switch from one tool to another in a matter of minutes.

SmartBoom™

Reduces Stress and Vibrations Transmitted to the Machine

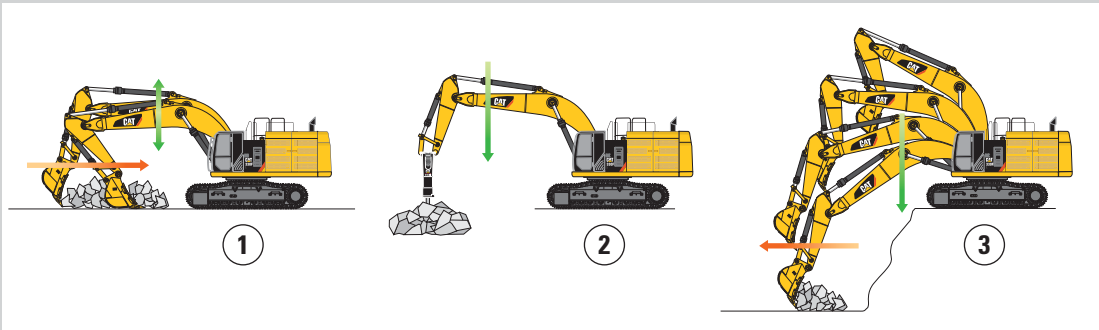

Rock Scraping (1)

Scraping rock and finishing work is easy and fast. SmartBoom simplifies the task and allows the operator to fully concentrate on the stick and bucket while the boom freely goes up and down without using pump flow.

Hammer Work (2)

It has never been this productive and operator-friendly. The front parts automatically follow the hammer while penetrating the rock. Blank shots or excessive force on the hammer are avoided, resulting in longer life for the hammer and machine. Similar advantages are applicable when using vibratory plates.

Truck Loading (3)

Loading trucks from a bench is more productive and fuel efficient as the return cycle is reduced while the boom down function does not require pump flow.

Boom and Stick Oil Re-circulation for Added Efficiency

The 330F L/F LN regenerates the flow of oil from the head end of the boom and stick cylinders to the rod end of the boom and stick cylinders during the work cycle to save energy and improve fuel efficiency.

It's optimized for any dial speed setting you select, which results in less pressure loss for higher controllability, more productivity, and lower operating costs for you.

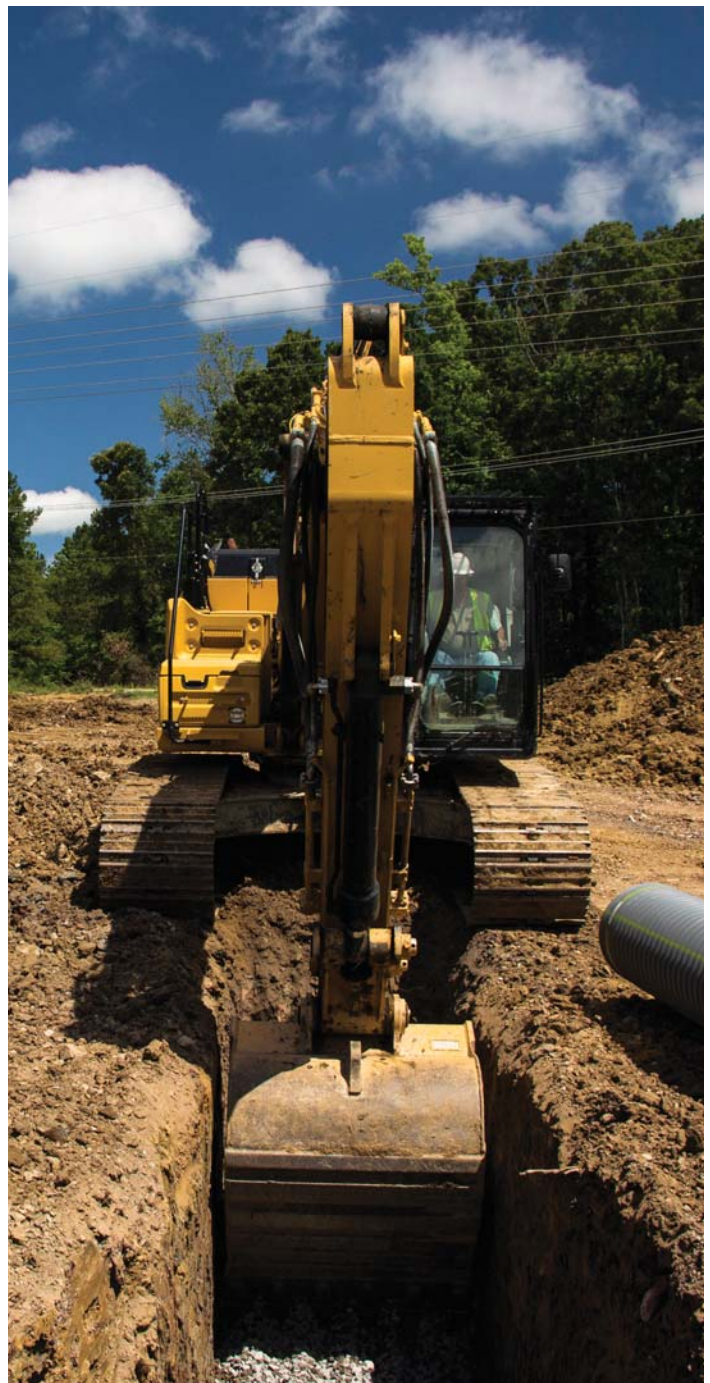



Ground-Level Access

You can reach most routine maintenance items like fluid taps and grease points from the safety and convenience of ground level. Not only do compartments feature wide service doors designed to help prevent debris entry, but they also securely latch in place to help make your service work simpler.

Serviceable

Designed to make your maintenance quick and easy



A Cool Design

The high-ambient cooling system features a fuel-saving variable-speed fan and a side-by-side-mounted radiator and oil and air coolers for easy cleaning. Wider clearance between the two make blowing off debris easy for you, which can help improve your machine's reliability and performance.

A Fresh Idea

When you select ventilation inside the cab, outside air enters through the fresh air filter. The filter is conveniently located on the side of the cab to make it easy to reach and replace, and it is protected by a lockable door that can be opened with the engine key.

Smart Refuel

Smart refuel is an on-board pump system that lets you fill the machine quickly from an external source like a fuel drum. What's smart about it is that it automatically stops when the fuel tank is full or the fuel source is empty, eliminating guess work and premature pump wear.

Quick and Convenient Fluids Service

The fuel tank's drain cock makes it easy and simple for you to remove water and sediment during routine maintenance. Plus an integrated fuel level indicator pops up to help you reduce the possibility of fuel tank overfilling.

Safe Work Environment

Features to help protect you day in and day out



A Safe, Quiet Cab

The ROPS-certified cab provides you with a safe working environment. It also contributes to your comfort because it's attached to a reinforced frame with special viscous mounts that limit vibration and unnecessary sound. Add in special roof lining and sealing and you have a cab that's as quiet inside as any of today's highway trucks.

Optional Falling Object Guards (FOGS) further protect you from debris coming to the cab.

Great Views

Ample glass coupled with the standard parallel wiper system, gives you excellent visibility out front and to the side, and the standard rearview and side-view camera gives you a clear field of view behind the machine through the cab monitor.

Smart Lighting

Halogen lights provide plenty of illumination, and the cab and boom lights can be programmed to stay on for up to 90 seconds after the engine has been turned off to help you safely exit the machine.

Secure Contact Points

Multiple large steps get you into the cab as well as a leg up to the compartments. Extended hand and guard rails allow you to safely climb to the upper deck. Anti-skid plates reduce your slipping hazards in all types of weather conditions, and they can be removed for cleaning.



Attachments

Do more jobs with one machine





Get the Most from One Machine

The 330F L/F LN is a versatile machine that packs a lot of performance into a small package. You can easily expand that performance by utilizing a variety of attachments offered by Cat Work Tools.

Change Jobs Quickly

Cat quick couplers bring the ability to quickly change attachments and switch from job to job. The CW Dedicated or the Cat Pin Grabber couplers are the secure way to decrease downtime and increase job site flexibility and overall productivity.

Dig, Rip and Load

A wide range of buckets dig everything from basic top soil to extreme, harsh material like ore and high quartzite granite. Rip through rock as an alternative to blasting in quarries. High-capacity buckets load trucks in a minimum number of passes for maximum productivity.

Break, Demolish and Scrap

A hydraulic hammer ably equips your machine for breaking rock in quarries. It will also make taking down bridge pillars and heavily reinforced concrete on road demolition jobs no problem.

Multi-processor and pulverizer attachments make your machine ideal for demolition jobs and processing the resulting debris. Shears with 360° rotation mount to the machine for processing scrap steel and metal.

Set Up Your Machine for Profitability

Your Cat dealer can install hydraulic kits to properly operate all Cat Work Tool attachments, maximizing the machine's uptime and your profit.



1) CW Dedicated Quick Coupler 2) Cat Pin Grabber Coupler
3) General Duty (GD) 4) Heavy Duty (HD)
5) Severe Duty (SD) 6) Extreme Duty (XD)

Cat Connect Technologies

Monitor, manage, and enhance job site operations



Cat Connect makes smart use of technology and services to improve your job site efficiency. Using the data from technology-equipped machines, you'll get more information and insight into your equipment and operations than ever before.

Cat Connect technologies offer improvements in these key areas:



EQUIPMENT
MANAGEMENT

Equipment Management – increase uptime and reduce operating costs.



PRODUCTIVITY

Productivity – monitor production and manage job site efficiency.



SAFETY

Safety – enhance job site awareness to keep your people and equipment safe.

LINK Technologies

LINK technologies, like Product Link™, are deeply integrated into your machine and wirelessly communicates key information, including location, hours, fuel usage, idle time and event codes.

Product Link/VisionLink®

Easy access to Product Link data via the online VisionLink user interface can help you see how your machine or fleet is performing. You can use this information to make timely, fact based decisions that can boost job site efficiency and productivity, and lower costs.



GRADE Technologies

Grade technologies combine digital design data and in-cab guidance to help you reach target grade quickly and accurately, with minimal staking and checking. That means you'll be more productive, complete jobs faster, in fewer passes, using less fuel, at a lower cost.



Cat GRADE with ASSIST Tilt Bucket Capability

Cat GRADE with ASSIST helps operators of all skill levels dig a level base with the right slope each and every time, and now it works with tilt buckets. With a touch of a button, the simple-to-use system automates boom and bucket movements to help operators reach target grade up to 45% faster than using traditional techniques.

Cat Grade Control Depth and Slope

The factory integrated Cat Grade Control system delivers 2D bucket tip elevation guidance to the cab to help operators create precise planes and slopes with ease. Real-time bucket tip elevation guidance on the easy-to-read standard cab monitor indicates how much to cut or fill. Fast response sensors deliver immediate feedback, while optional integrated joystick buttons help operators make quick adjustments to maintain consistent, quality grades. Built-in alerts can be set to warn the operator if the linkage or bucket approaches a predefined elevation or depth, such as when working in areas with low ceilings, or digging near water lines. Staking and checking is minimized, which reduces ground crews and enhances job site safety.

Works best in simple 2D applications, such as digging basements or grading steep embankments. Easily upgrade to AccuGrade™ when 3D control is required.

Cat AccuGrade

The dealer-installed AccuGrade system provides 3D guidance for making complex cuts and contours, eliminating the need for staking and checking. A dedicated monitor displays a digital design plan with 3D bucket tip positioning and elevation guidance, indicating precisely where to work and how much to cut or fill.

Plug and play capability on the 330F L/F LN simplifies upgrading. Choose from satellite (GNSS) control for large projects with complex designs or total station (UTS) systems in areas with limited reception.





Complete Customer Care

Unmatched support makes the difference

Sustainable Generations ahead in every way

- The C7.1 ACERT engine meets Stage IV emission standards.
- The 330F L/F LN performs the same amount of work while burning less fuel than the previous E Series model, which means more efficiency, less resources consumed, and fewer emissions.
- The 330F L/F LN has the flexibility of running on either ultra-low-sulfur diesel (ULSD) fuel with 10 ppm of sulfur or less or biodiesel (up to B20) fuel blended with ULSD.
- A ground-level overfill indicator rises when the tank is full to help the operator avoid spilling.
- The QuickEvac™ option ensures fast, easy, and secure changing of engine and hydraulic oil.
- The 330F L/F LN is built to be rebuilt with major structures and components capable of being remanufactured to reduce waste and replacement costs.
- An engine oil filter eliminates the need for painted metal cans and aluminum top plates. The cartridge-style spin-on housing enables the internal filter to be separated and replaced; the used internal element can be incinerated to help reduce waste.
- The 330F L/F LN is an efficient, productive machine that's designed to conserve our natural resources for generations ahead.

Worldwide Parts Availability

Cat dealers utilize a worldwide parts network to maximize your machines' uptime. Plus they can help you save money with Cat remanufactured components.

Financial Options Just for You

Consider financing options and day-to-day operating costs. Look at dealer services that can be included in the machine's cost to yield lower owning and operating costs over time.

What's Best for You Today...and Tomorrow

Repair, rebuild, or replace? Your Cat dealer can help you evaluate the cost involved so you can make the best choice for your business.



330F L/F LN Hydraulic Excavator Specifications

Engine

Engine Model	Cat C7.1 ACERT
Power – ISO 14396 (metric)	178 kW (242 PS)
Power – ISO 9249 (metric)	175 kW (238 PS)
Engine rpm	
Operation	1,750 rpm
Travel	1,800 rpm
Bore	105 mm
Stroke	135 mm
Displacement	7.01 L

• Power Rating at 1,800 rpm.

Weights

Minimum Weight*	29 110 kg
Maximum Weight**	30 730 kg

*Long Narrow Undercarriage, 6.15 m Reach Boom, R2.65CB2 Stick, 600 mm Triple Grouser Shoes, 5.8 mt Counterweight, 1.71 m³ Bucket.

**Long Undercarriage, 6.15 m Reach Boom, R3.2CB2 Stick, 900 mm Triple Grouser Shoes, 6.75 mt Counterweight, 1.51 m³ Bucket.

Hydraulic System

Maximum Flow	
Main System	2 × 247 L/min (494 L/min)
Swing System	240 L/min
Pilot System	30 L/min
Maximum Pressure	
Equipment – Normal	35 000 kPa
Equipment – Heavy Lift	38 000 kPa
Travel	37 000 kPa
Swing	27 400 kPa
Pilot System	4100 kPa
Boom Cylinder	
Bore	140 mm
Stroke	1407 mm
Stick Cylinder	
Bore	150 mm
Stroke	1646 mm
CB2 Bucket Cylinder	
Bore	150 mm
Stroke	1151 mm

Drive

Maximum Gradeability	35°/70%
Maximum Drawbar Pull	247 kN
Maximum Travel Speed	5.1 km/h

Swing Mechanism

Swing Speed	9.6 rpm
Maximum Swing Torque	105 kN·m

Service Refill Capacities

Fuel Tank Capacity	520 L
Cooling System	30 L
Engine Oil (with filter)	24 L
Swing Drive (each)	9 L
Final Drive (each)	6 L
Hydraulic System Oil Capacity (including tank)	310 L
Hydraulic Tank Oil	175 L
DEF Tank	41 L

Track

Number of Shoes (each side)	50
Number of Track Rollers (each side)	9
Number of Carrier Rollers (each side)	2
Track Options	600 mm 700 mm 800 mm 900 mm

Sound Performance

Operator Sound Pressure Level – ISO 6396:2008	72 dB(A)
Exterior Sound Power Level – ISO 6395:2008	104 dB(A)*

- Hearing protection may be needed when operating with an open operator station and cab (when not properly maintained or doors/windows open) for extended periods or in a noisy environment.
- When properly installed and maintained, the cab offered by Caterpillar, when tested with doors and windows closed according to ANSI/SAE J1166 OCT98, meets requirements for operator sound exposure limits in effect at time of manufacture.

*as per European Union Directive 2000/14/EC as amended by 2005/88/EC

Standards

Brakes	ISO 10265 2008
Cab/FOGS	ISO 10262 1998
ROPS Cab	ISO 12117-2
DEF	Must meet ISO 22241

Air Conditioning System

The air conditioning system on this machine contains the fluorinated greenhouse gas refrigerant R134a (Global Warming Potential = 1430). The system contains 1 kg of refrigerant which has a CO₂ equivalent of 1.43 metric tonnes.

330F L/F LN Hydraulic Excavator Specifications

Dimensions

All dimensions are approximate.

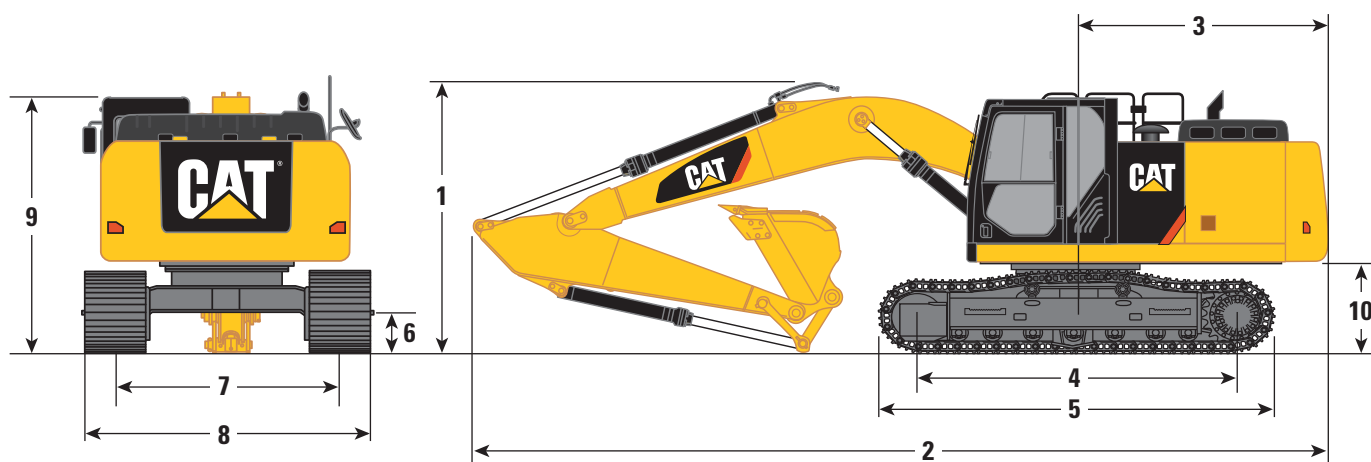

Stick Size	Reach Boom 6.15 m	
	R3.2CB2	R2.65CB2
1 Shipping Height*	3370 mm	3450 mm
2 Shipping Length	10 390 mm	10 400 mm
3 Tail Swing Radius	3090 mm	3090 mm
4 Length to Center of Rollers		
Long Undercarriage	3990 mm	3990 mm
Long Narrow Undercarriage	3990 mm	3990 mm
5 Track Length		
Long Undercarriage	4860 mm	4860 mm
Long Narrow Undercarriage	4860 mm	4860 mm
6 Ground Clearance**	490 mm	490 mm
7 Track Gauge		
Long Undercarriage	2590 mm	2590 mm
Long Narrow Undercarriage	2390 mm	2390 mm
8 Transport Width		
Long Undercarriage – 600 mm Shoes	3190 mm	3190 mm
Long Undercarriage – 700 mm Shoes	3290 mm	3290 mm
Long Undercarriage – 800 mm Shoes	3390 mm	3390 mm
Long Undercarriage – 900 mm Shoes	3490 mm	3490 mm
Long Narrow Undercarriage – 600 mm Shoes	2990 mm	2990 mm
Long Narrow Undercarriage – 700 mm Shoes	3090 mm	3090 mm
Long Narrow Undercarriage – 800 mm Shoes	3190 mm	3190 mm
9 Cab Height*	3040 mm	3040 mm
10 Counterweight Clearance**	1110 mm	1110 mm
Bucket Type	HD	HD
Bucket Tip Radius	1650 mm	1650 mm

*Including shoe lug height.

**Without shoe lug height.

330F L/F LN Hydraulic Excavator Specifications

Working Ranges

All dimensions are approximate.

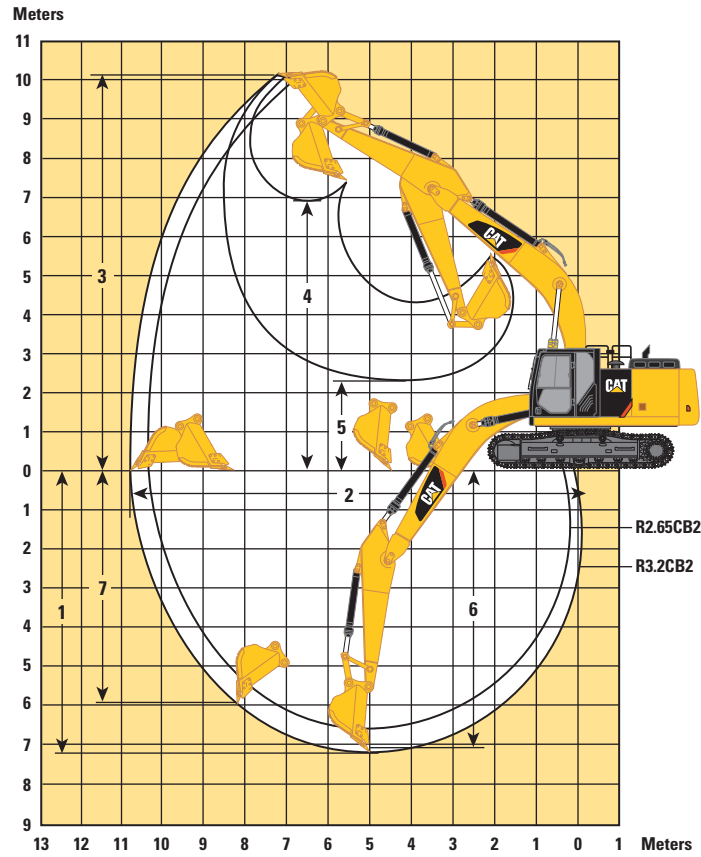

Stick Size	Reach Boom 6.15 m	
	R3.2CB2	R2.65CB2
1 Maximum Digging Depth	7250 mm	6700 mm
2 Maximum Reach at Ground Level	10 680 mm	10 200 mm
3 Maximum Cutting Height	10 010 mm	9900 mm
4 Maximum Loading Height	6950 mm	6800 mm
5 Minimum Loading Height	2290 mm	2840 mm
6 Maximum Depth Cut for 2440 mm Level Bottom	7090 mm	6520 mm
7 Maximum Vertical Wall Digging Depth	5980 mm	5680 mm
Bucket Type	HD	GD
Bucket Tip Radius	1650 mm	1650 mm
Stick Cylinder Force (ISO)	126 kN	145 kN
Bucket Cylinder Force (ISO)	179 kN	180 kN

330F L/F LN Hydraulic Excavator Specifications

Operating Weights and Ground Pressures

Boom	Stick	Bucket	600 mm Shoes (TG)		600 mm Shoes (TG HD)			
			Weight	Ground Pressure	Weight	Ground Pressure		
			kg	kPa	kg	kPa		
5.8 mt Counterweight								
Long Undercarriage								
Reach Boom (6.15 m)	R3.2CB2	CB1350HD	29 380	55.9	29 930	56.9		
Reach Boom (6.15 m)	R2.65CB2	CB1350HD	29 220	55.6	29 770	56.6		
Long Narrow Undercarriage								
Reach Boom (6.15 m)	R3.2CB2	CB1350HD	29 360	55.8	29 910	56.9		
Reach Boom (6.15 m)	R2.65CB2	CB1350HD	29 200	55.5	29 750	56.6		
Boom	Stick	Bucket	700 mm Shoes (TG HD)		800 mm Shoes (TG)		900 mm Shoes (TG)	
			Weight	Ground Pressure	Weight	Ground Pressure	Weight	Ground Pressure
			kg	kPa	kg	kPa	kg	kPa
5.8 mt Counterweight								
Long Undercarriage								
Reach Boom (6.15 m)	R3.2CB2	CB1350HD	30 360	49.5	30 350	43.3	30 730	38.9
Reach Boom (6.15 m)	R2.65CB2	CB1350HD	30 200	49.2	30 190	43.0	30 570	38.7
Long Narrow Undercarriage								
Reach Boom (6.15 m)	R3.2CB2	CB1350HD	30 340	49.4	30 330	43.2	—	—
Reach Boom (6.15 m)	R2.65CB2	CB1350HD	30 180	49.2	30 170	43.0	—	—

Operating Weight is based on ISO 6016.

330F L/F LN Hydraulic Excavator Specifications

Major Component Weights

Boom	
Reach Boom – 6.15 m	2240 kg
Sticks	
R3.2CB2	1180 kg
R2.65CB2	1020 kg
Bucket Linkage	
CB2 with Lifting Eye	290 kg
Undercarriages	
Long Undercarriage	6000 kg
Long Narrow Undercarriage	5980 kg
Tracks	
600 mm Triple Grouser Shoes for Long Undercarriage	3580 kg
600 mm Triple Grouser HD Shoes for Long Undercarriage	4130 kg
700 mm Triple Grouser HD Shoes for Long Undercarriage	4560 kg
800 mm Triple Grouser Shoes for Long Undercarriage	4550 kg
900 mm Triple Grouser Shoes for Long Undercarriage	4930 kg
Common Buckets	
Bucket: CB1233HD 1.33 m ³	1050 kg
Bucket: CB1350HD 1.54 m ³	1130 kg
Bucket: CB1500GD 1.76 m ³	1040 kg

330F L/F LN Hydraulic Excavator Specifications

330F L Reach Boom Lift Capacities – Counterweight: 5.8 mt – without Bucket – Heavy Lift On

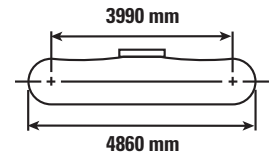
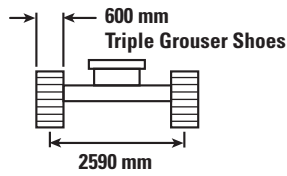
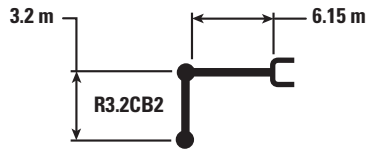

Lift Height	Unit	1500 mm		3000 mm		4500 mm		6000 mm		7500 mm		9000 mm		mm		
		Diagram 1	Diagram 2	Diagram 1	Diagram 2	Diagram 1	Diagram 2	Diagram 1	Diagram 2	Diagram 1	Diagram 2	Diagram 1	Diagram 2	Diagram 1	Diagram 2	
7500 mm	kg													*5600	*5600	7280
6000 mm	kg									*7900	5950			*5350	5100	8230
4500 mm	kg							*9200	8200	*8350	5850			*5350	4500	8830
3000 mm	kg					*14 200	11 900	*10 750	7800	8700	5650	*6500	4300	*5450	4200	9140
1500 mm	kg					*16 900	11 150	11 900	7450	8500	5450	6500	4200	*5800	4100	9190
0 mm	kg					*18 200	10 800	11 650	7200	8350	5300			*6400	4150	8990
-1500 mm	kg	*6750	*6750	*10 600	*10 600	*18 200	10 700	11 500	7100	8250	5250			6900	4450	8530
-3000 mm	kg	*12 150	*12 150	*17 150	*17 150	*17 050	10 800	11 550	7100	8300	5300			7950	5100	7740
-4500 mm	kg			*19 800	*19 800	*14 550	11 000	*10 750	7300					*9450	6550	6520



ISO 10567



*Indicates that the load is limited by hydraulic lifting capacity rather than tipping load. The above loads are in compliance with hydraulic excavator lift capacity standard ISO 10567:2007. They do not exceed 87% of hydraulic lifting capacity or 75% of tipping load. Weight of all lifting accessories must be deducted from the above lifting capacities. Lifting capacities are based on the machine standing on a firm, uniform supporting surface. The use of a work tool attachment point to handle/lift objects, could affect the machine lift performance.

Lift capacity stays with ±5% for all available track shoes.

Always refer to the appropriate Operation and Maintenance Manual for specific product information.

330F L/F LN Hydraulic Excavator Specifications

330F L Reach Boom Lift Capacities – Counterweight: 5.8 mt – without Bucket – Heavy Lift On

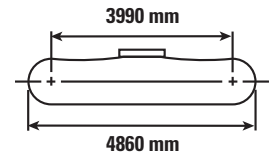
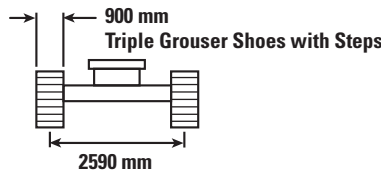
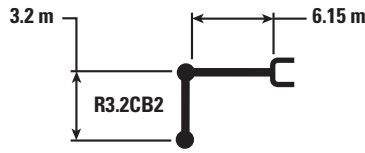

		1500 mm		3000 mm		4500 mm		6000 mm		7500 mm		9000 mm		mm		
7500 mm	kg													*5600	*5600	7280
6000 mm	kg									*7900	6200			*5350	5300	8230
4500 mm	kg							*9200	8500	*8350	6050			*5350	4700	8830
3000 mm	kg					*14 200	12 350	*10 750	8100	9050	5850	*6500	4450	*5450	4350	9140
1500 mm	kg					*16 900	11 600	*12 250	7750	8850	5700	6750	4400	*5800	4250	9190
0 mm	kg					*18 200	11 250	12 150	7500	8700	5550			*6400	4350	8990
-1500 mm	kg	*6750	*6750	*10 600	*10 600	*18 200	11 150	12 000	7400	8600	5450			7200	4650	8530
-3000 mm	kg	*12 150	*12 150	*17 150	*17 150	*17 050	11 250	12 050	7400	8650	5500			8300	5300	7740
-4500 mm	kg			*19 800	*19 800	*14 550	11 450	*10 750	7600					*9450	6800	6520



ISO 10567



*Indicates that the load is limited by hydraulic lifting capacity rather than tipping load. The above loads are in compliance with hydraulic excavator lift capacity standard ISO 10567:2007. They do not exceed 87% of hydraulic lifting capacity or 75% of tipping load. Weight of all lifting accessories must be deducted from the above lifting capacities. Lifting capacities are based on the machine standing on a firm, uniform supporting surface. The use of a work tool attachment point to handle/lift objects, could affect the machine lift performance.

Lift capacity stays with ±5% for all available track shoes.

Always refer to the appropriate Operation and Maintenance Manual for specific product information.

330F L/F LN Hydraulic Excavator Specifications

330F L Reach Boom Lift Capacities – Counterweight: 5.8 mt – without Bucket – Heavy Lift On

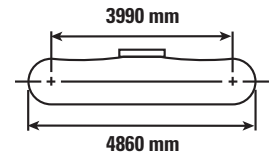
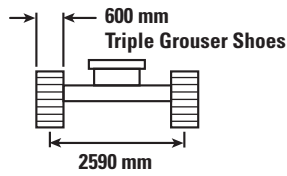
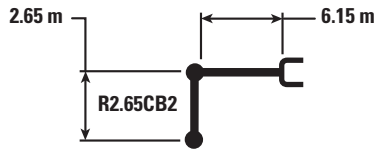

Reach (mm)	Unit	3000 mm		4500 mm		6000 mm		7500 mm		mm		
		Hydraulic	Tipping	Hydraulic	Tipping	Hydraulic	Tipping	Hydraulic	Tipping	Hydraulic	Tipping	
7500 mm	kg									*7350	7150	6670
6000 mm	kg					*8950	8400	*8400	5900	*6900	5650	7700
4500 mm	kg			*12 300	*12 300	*10 050	8150	8900	5800	*6850	4950	8340
3000 mm	kg			*15 500	11 750	*11 500	7800	8700	5650	7000	4600	8670
1500 mm	kg			*16 550	11 150	11 950	7450	8550	5500	6850	4450	8720
0 mm	kg			*17 550	10 900	11 700	7300	8400	5400	7050	4550	8510
-1500 mm	kg	*10 350	*10 350	*18 000	10 900	11 650	7200	8400	5350	7650	4950	8020
-3000 mm	kg	*19 400	*19 400	*16 450	11 000	11 700	7300			9050	5800	7180
-4500 mm	kg	*17 350	*17 350	*13 150	11 300					*9600	7850	5830



ISO 10567



*Indicates that the load is limited by hydraulic lifting capacity rather than tipping load. The above loads are in compliance with hydraulic excavator lift capacity standard ISO 10567:2007. They do not exceed 87% of hydraulic lifting capacity or 75% of tipping load. Weight of all lifting accessories must be deducted from the above lifting capacities. Lifting capacities are based on the machine standing on a firm, uniform supporting surface. The use of a work tool attachment point to handle/lift objects, could affect the machine lift performance.

Lift capacity stays with ±5% for all available track shoes.

Always refer to the appropriate Operation and Maintenance Manual for specific product information.

330F L/F LN Hydraulic Excavator Specifications

330F L Reach Boom Lift Capacities – Counterweight: 5.8 mt – without Bucket – Heavy Lift On

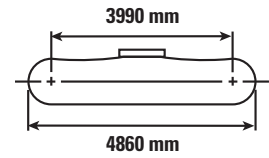
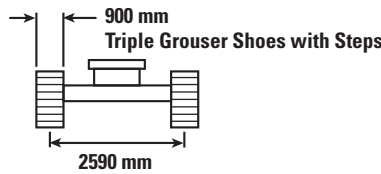
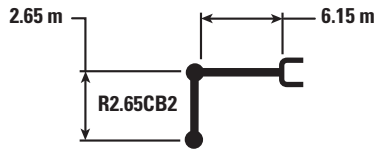

Reach (mm)	Unit	3000 mm		4500 mm		6000 mm		7500 mm		mm		
		Hydraulic	Tipping	Hydraulic	Tipping	Hydraulic	Tipping	Hydraulic	Tipping	Hydraulic	Tipping	
7500 mm	kg									*7350	*7350	6670
6000 mm	kg					*8950	8700	*8400	6150	*6900	5900	7700
4500 mm	kg			*12 300	*12 300	*10 050	8450	*9000	6050	*6850	5150	8340
3000 mm	kg			*15 500	12 200	*11 500	8100	9100	5900	*7000	4750	8670
1500 mm	kg			*16 550	11 600	12 450	7800	8900	5750	7150	4650	8720
0 mm	kg			*17 550	11 400	12 200	7600	8800	5600	7350	4750	8510
-1500 mm	kg	*10 350	*10 350	*18 000	11 350	12 150	7500	8750	5600	8000	5150	8020
-3000 mm	kg	*19 400	*19 400	*16 450	11 500	12 200	7600			9400	6000	7180
-4500 mm	kg	*17 350	*17 350	*13 150	11 750					*9600	8150	5830



ISO 10567



*Indicates that the load is limited by hydraulic lifting capacity rather than tipping load. The above loads are in compliance with hydraulic excavator lift capacity standard ISO 10567:2007. They do not exceed 87% of hydraulic lifting capacity or 75% of tipping load. Weight of all lifting accessories must be deducted from the above lifting capacities. Lifting capacities are based on the machine standing on a firm, uniform supporting surface. The use of a work tool attachment point to handle/lift objects, could affect the machine lift performance.

Lift capacity stays with ±5% for all available track shoes.

Always refer to the appropriate Operation and Maintenance Manual for specific product information.

330F L/F LN Hydraulic Excavator Specifications

330F LN Reach Boom Lift Capacities – Counterweight: 5.8 mt – without Bucket – Heavy Lift On

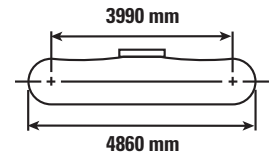
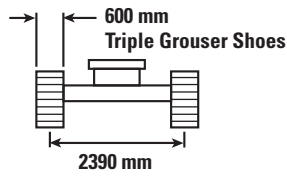
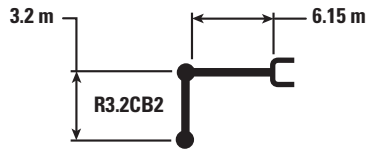

Reach (mm)	Unit	1500 mm		3000 mm		4500 mm		6000 mm		7500 mm		9000 mm		mm		
		Diagram	Diagram	Diagram	Diagram	Diagram	Diagram	Diagram	Diagram	Diagram	Diagram	Diagram	Diagram	Diagram	Diagram	
7500 mm	kg													*5600	*5600	7280
6000 mm	kg									*7900	5500			*5350	4700	8230
4500 mm	kg							*9200	7550	*8350	5400			*5350	4150	8830
3000 mm	kg					*14 200	10 850	*10 750	7200	8650	5200	*6500	3950	*5450	3850	9140
1500 mm	kg					*16 900	10 150	11 850	6850	8450	5000	6450	3850	*5800	3750	9190
0 mm	kg					*18 200	9800	11 600	6600	8300	4900			*6400	3800	8990
-1500 mm	kg	*6750	*6750	*10 600	*10 600	*18 200	9700	11 450	6500	8200	4800			6850	4100	8530
-3000 mm	kg	*12 150	*12 150	*17 150	*17 150	*17 050	9800	11 500	6500	8250	4850			7900	4700	7740
-4500 mm	kg			*19 800	19 500	*14 550	10 000	*10 750	6700					*9450	6000	6520



ISO 10567



*Indicates that the load is limited by hydraulic lifting capacity rather than tipping load. The above loads are in compliance with hydraulic excavator lift capacity standard ISO 10567:2007. They do not exceed 87% of hydraulic lifting capacity or 75% of tipping load. Weight of all lifting accessories must be deducted from the above lifting capacities. Lifting capacities are based on the machine standing on a firm, uniform supporting surface. The use of a work tool attachment point to handle/lift objects, could affect the machine lift performance.

Lift capacity stays with ±5% for all available track shoes.

Always refer to the appropriate Operation and Maintenance Manual for specific product information.

330F L/F LN Hydraulic Excavator Specifications

330F LN Reach Boom Lift Capacities – Counterweight: 5.8 mt – without Bucket – Heavy Lift On

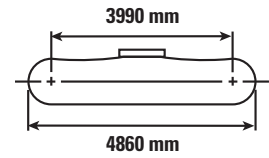
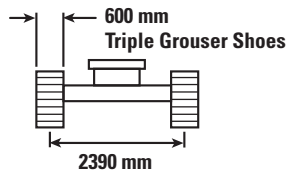
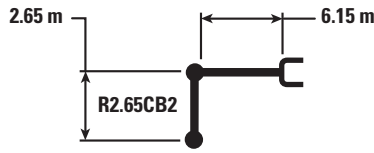

Reach (mm)	Unit	3000 mm		4500 mm		6000 mm		7500 mm		mm		
		Diagram 1	Diagram 2	Diagram 1	Diagram 2	Diagram 1	Diagram 2	Diagram 1	Diagram 2	Diagram 1	Diagram 2	
7500 mm	kg									*7350	6600	6670
6000 mm	kg					*8950	7800	*8400	5500	*6900	5250	7700
4500 mm	kg			*12 300	11 500	*10 050	7500	8850	5400	*6850	4550	8340
3000 mm	kg			*15 500	10 700	*11 500	7150	8650	5250	6950	4250	8670
1500 mm	kg			*16 550	10 150	11 900	6850	8500	5100	6800	4100	8720
0 mm	kg			*17 550	9950	11 650	6700	8350	4950	7000	4200	8510
-1500 mm	kg	*10 350	*10 350	*18 000	9900	11 600	6600	8350	4950	7600	4550	8020
-3000 mm	kg	*19 400	*19 400	*16 450	10 050	11 650	6700			9000	5300	7180
-4500 mm	kg	*17 350	*17 350	*13 150	10 300					*9600	7200	5830



ISO 10567



*Indicates that the load is limited by hydraulic lifting capacity rather than tipping load. The above loads are in compliance with hydraulic excavator lift capacity standard ISO 10567:2007. They do not exceed 87% of hydraulic lifting capacity or 75% of tipping load. Weight of all lifting accessories must be deducted from the above lifting capacities. Lifting capacities are based on the machine standing on a firm, uniform supporting surface. The use of a work tool attachment point to handle/lift objects, could affect the machine lift performance.

Lift capacity stays with ±5% for all available track shoes.

Always refer to the appropriate Operation and Maintenance Manual for specific product information.

330F L/F LN Hydraulic Excavator Specifications

Bucket Specifications and Compatibility

	Linkage	Width mm	Capacity m ³	Weight kg	Fill %	330F L		330F LN	
						Reach Boom		Reach Boom	
						R3.2	R2.65	R3.2	R2.65
Without Quick Coupler									
General Duty (GD)	CB	750	0.71	730	100	●	●	●	●
	CB	1050	1.12	864	100	●	●	●	●
	CB	1200	1.33	927	100	●	●	●	●
	CB	1350	1.54	1009	100	●	●	⊙	●
	CB	1500	1.76	1074	100	x	●	x	⊙
Heavy Duty (HD)	CB	1350	1.54	1134	100	●	●	⊙	●
	CB	1500	1.76	1229	100	x	●	x	⊙
Severe Duty (SD)	CB	1350	1.56	1245	90	●	●	⊙	●
Maximum load pin-on (payload + bucket)					kg	4485	4955	3970	4400
With Center-Lock™ Coupler									
General Duty (GD)	CB	750	0.71	730	100	●	●	●	●
	CB	1050	1.12	864	100	●	●	●	●
	CB	1200	1.33	927	100	●	●	⊙	●
	CB	1350	1.54	1009	100	⊙	●	⊖	⊙
	CB	1500	1.76	1074	100	⊖	⊙	○	⊖
Heavy Duty (HD)	CB	1350	1.54	1134	100	⊙	●	⊖	⊙
	CB	1500	1.76	1229	100	⊖	⊙	○	⊖
Severe Duty (SD)	CB	1350	1.56	1245	90	⊙	●	⊖	⊙
Maximum load with coupler (payload + bucket)					kg	3980	4450	3465	3895

The above loads are in compliance with hydraulic excavator standard EN474. They do not exceed 87% of hydraulic lifting capacity or 75% of tipping capacity over the side with front linkage fully extended at ground line with bucket curled.

Capacity based on ISO 7451.

Bucket weight with General Duty tips.

Maximum Material Density:

- 2100 kg/m³
- ⊙ 1800 kg/m³
- ⊖ 1500 kg/m³
- 1200 kg/m³
- x Not recommended

Caterpillar recommends using appropriate work tools to maximize the value customers receive from our products. Use of work tools, including buckets, which are outside of Caterpillar's recommendations or specifications for weight, dimensions, flows, pressures, etc. may result in less-than-optimal performance, including but not limited to reductions in production, stability, reliability, and component durability. Improper use of a work tool resulting in sweeping, prying, twisting and/or catching of heavy loads will reduce the life of the boom and stick.

330F L/F LN Hydraulic Excavator Specifications

Bucket Specifications and Compatibility

	Linkage	Width mm	Capacity m ³	Weight kg	Fill %	330F L		330F LN	
						Reach Boom		Reach Boom	
						R3.2	R2.65	R3.2	R2.65
With Quick Coupler (CW45, CW45s)									
General Duty (GD)	CB	750	0.7	693	100	●	●	●	●
	CB	1350	1.5	1008	100	⊙	●	⊖	⊙
	CB	1500	1.76	1074	100	⊖	⊙	○	⊖
	CB	1650	1.97	1157	100	⊖	⊖	○	○
Heavy Duty (HD)	CB	1200	1.33	1061	100	●	●	⊙	●
	CB	1350	1.54	1134	100	⊙	●	⊖	⊙
	CB	1500	1.76	1229	100	⊖	⊙	○	⊖
	CB	1650	1.97	1302	100	○	⊖	◇	○
Maximum load with coupler (payload + bucket)					kg	4021	4491	3506	3936

Maximum Material Density:

- 2100 kg/m³
- ⊙ 1800 kg/m³
- ⊖ 1500 kg/m³
- 1200 kg/m³
- ◇ 900 kg/m³

The above loads are in compliance with hydraulic excavator standard EN474. They do not exceed 87% of hydraulic lifting capacity or 75% of tipping capacity over the side with front linkage fully extended at ground line with bucket curled.

Capacity based on ISO 7451.

Bucket weight with General Duty tips.

Caterpillar recommends using appropriate work tools to maximize the value customers receive from our products. Use of work tools, including buckets, which are outside of Caterpillar's recommendations or specifications for weight, dimensions, flows, pressures, etc. may result in less-than-optimal performance, including but not limited to reductions in production, stability, reliability, and component durability. Improper use of a work tool resulting in sweeping, prying, twisting and/or catching of heavy loads will reduce the life of the boom and stick.

330F L/F LN Hydraulic Excavator Specifications

330F L Work Tool Offering Guide*

Boom Type	Reach Boom	
Stick Size	R3.2	R2.65
Hydraulic Hammer	H120E s H130E s H140E s	H120E s H130E s H140E s
Multi-Processor	MP324 CC Jaw MP324 D Jaw MP324 P Jaw** MP324 S Jaw MP324 TS Jaw** MP324 U Jaw	MP324 CC Jaw MP324 D Jaw MP324 P Jaw MP324 S Jaw MP324 TS Jaw MP324 U Jaw
Crusher	P325	P325
Pulverizer	P225	P225
Demolition and Sorting Grapple	G320B G325B**	G320B G325B
Mobile Scrap and Demolition Shear	S320B S325B*** S340B#	S320B S325B S340B#
Compactor (Vibratory Plate)	CVP110	CVP110
Orange Peel Grapple		
Center-Lock Pin Grabber Coupler		
CW Dedicated Quick Coupler		

These work tools are available for the 330F L.
Consult your Cat dealer for proper match.

*Matches are dependent on excavator configurations. Consult your Cat dealer for proper work tool match.

**Pin-on or dedicated coupler.

***Pin-on only.

#Boom mount.

330F L/F LN Hydraulic Excavator Specifications

330F LN Work Tool Offering Guide*

Boom Type	Reach Boom	
Stick Size	R3.2	R2.65
Hydraulic Hammer	H120E s H130E s H140E s	H120E s H130E s H140E s
Multi-Processor	MP324 CC Jaw**^ MP324 D Jaw**^ MP324 P Jaw**^ MP324 S Jaw^ MP324 TS Jaw**^ MP324 U Jaw**^	MP324 CC Jaw MP324 D Jaw MP324 P Jaw MP324 S Jaw MP324 TS Jaw MP324 U Jaw
Crusher	P325^^	P325
Pulverizer	P225^^	P225
Demolition and Sorting Grapple	G320B**^ G325B***	G320B G325B**^
Mobile Scrap and Demolition Shear	S320B S325B*** S340B#	S320B S325B**^ S340B#
Compactor (Vibratory Plate)	CVP110	CVP110
Orange Peel Grapple		
Center-Lock Pin Grabber Coupler		
CW Dedicated Quick Coupler		

These work tools are available for the 330F LN.
Consult your Cat dealer for proper match.

*Matches are dependent on excavator configurations. Consult your Cat dealer for proper work tool match.

**Pin-on or dedicated coupler.

***Pin-on only.

#Boom mount.

^Over the front only with dedicated coupler.

^^Over the front only with Center-Lock coupler.

Standard Equipment

Standard equipment may vary. Consult your Cat dealer for details.

CAB

- Parallel wiper and washer
- Mirrors
- Pressurized operator station with positive filtration
- Laminated glass front upper window and tempered other windows
- Sliding upper door window (left-hand cab door)
- Openable skylight as emergency exit
- Interior
 - Glass-breaking safety hammer
 - Coat hook
 - Beverage holder
 - Literature holder
 - Interior lighting
 - AM/FM radio mounting (DIN size)
 - Two 12V stereo speakers
 - Storage shelf suitable for lunch or toolbox
 - Power supply with 12V, two power outlets (10 amp)
 - Thumb wheel modulation joystick for use with combined auxiliary control
 - Air conditioner, heater and defroster with climate control
- Seat
 - Flexible seat belt
 - Adjustable armrest
 - Height adjustable joystick consoles
 - Neutral lever (lock out) for all controls
 - Travel control pedals with removable hand levers
 - Capability of installing two additional pedals
 - Two speed travel
 - Floor mat, washable
 - Adjustable high-back, heated and ventilated seat with air suspension

- Monitor
 - Clock
 - Video ready
 - Color LCD display with warning, filter/fluid change, and working hour information
 - Language display (full graphic and full color display)
 - Machine condition, error code and tool mode setting information
 - Start-up level check for engine oil, engine coolant and hydraulic oil
 - Warning, filter/fluid change and working hour information
 - Fuel consumption meter

ELECTRICAL

- 115 amp alternator
- Circuit breaker
- Battery, maintenance free
- Electric refueling pump, with auto shutoff and storage

ENGINE

- Cat C7.1 ACERT diesel engine
- Stage IV emission package
- 4600 m altitude capability with derate from 3000 m
- Up to B20 biodiesel capable
- Automatic engine speed control
- Electric priming pump
- Water separator in fuel line including water level sensor and indicator
- Economy and standard power modes
- Air cleaner
- Radial seal air filter
- Variable fan speed
- High ambient capability, 52° C
- Smart refuel pump

HYDRAULIC SYSTEM

- Boom and stick lowering control devices with SmartBoom
- Reverse swing dampening valve
- Automatic swing parking brake
- High-performance hydraulic return filter
- Regeneration circuit for boom and stick
- Capability of installing additional auxiliary circuits
- Heavy lift mode
- Sampling ports for Scheduled Oil Sampling (S·O·SSM)
- Tilt up Air-to-Air Aftercooler (ATAAC) for easy maintenance

LIGHTS

- Cab and boom lights with 90 second time delay
- Exterior lights integrated into storage box

UNDERCARRIAGE/UPPERFRAME

- Long or Long Narrow undercarriage
- Grease Lubricated Track GLT2, resin seal
- Heavy duty track roller and idler
- Towing eye on base frame
- Counterweight, 5.8 mt
- HD bottom guards
- HD travel motor guards

SAFETY AND SECURITY

- Cat one key security system
- Door locks
- Cap locks on fuel and hydraulic tanks
- Lockable external tool/storage box
- Signaling/warning horn
- Secondary engine shutoff switch
- Mirrors
- Rear vision and side-view camera
- Bolt on FOGS capability

INTEGRATED TECHNOLOGIES

- Product Link

Optional Equipment

Optional equipment may vary. Consult your Cat dealer for details.

FRONT LINKAGE

- Reach Boom 6.15 m (with or without Cat Grade Control)
 - R3.2 CB2 (with or without CGC)
 - R2.65CB2
 - CB2-family bucket linkage (with lifting eye)
- CW Dedicated or Cat Pin Grabber couplers

TRACK

- 900 mm triple grouser
- 800 mm triple grouser
- 700 mm triple grouser HD
- 600 mm triple grouser HD
- 600 mm triple grouser

GUARDS

- Track guiding guards
 - Full length
 - Segmented, three pieces

CAB

- Windshield
 - 70-30 split, sliding, removable lower windshield with in cab storage bracket
 - One-piece, fixed

HYDRAULIC SYSTEM

- HP hydraulic lines for boom and stick
- MP hydraulic lines for boom and stick
- QC hydraulic lines for boom and stick
- QC control

ELECTRICAL

- Cold weather starting package, –32° C
- Travel alarm
- Jumpstart

INTEGRATED TECHNOLOGIES

- Cat Grade Control (3D will be available in January, 2017)

ENGINE

- Quick drains, engine and hydraulic oil (QuickEvac)

DEALER INSTALLED KITS

- Cab
 - Rain protector for front windshield
 - Seat belt, retractable (76 mm width)
 - Ashtray for cup holder
- Guards
 - FOGS retrofit kit package
 - Mesh for front guard retrofit kit package
 - Mesh guard, lower half front
 - Side rubber bumper
- Safety and Security
 - Security system (MSS)
- Travel alarm
- Cat Grade with Assist for CGC (available in February, 2017)

For more complete information on Cat products, dealer services, and industry solutions, visit us on the web at www.cat.com

© 2017 Caterpillar
All rights reserved

Materials and specifications are subject to change without notice. Featured machines in photos may include additional equipment. See your Cat dealer for available options.

CAT, CATERPILLAR, SAFETY.CAT.COM, their respective logos, "Caterpillar Yellow" and the "Power Edge" trade dress, as well as corporate and product identity used herein, are trademarks of Caterpillar and may not be used without permission.

VisionLink is a trademark of Trimble Navigation Limited, registered in the United States and in other countries.

AEHQ7860-01
Replaces AEHQ7860
(EU)

